

SoloSpec™

Disposable Sigmoidoscopes

Instructions for Use

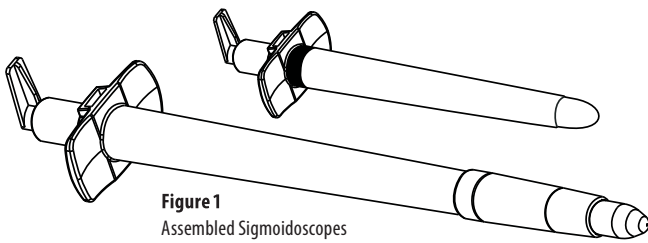

Figure 1
Assembled Sigmoidoscopes
(Body and Obturator), Small and Standard Sizes

by Orion Concepts Inc.

www.orionconceptsinc.com

INTENDED USE and INDICATIONS FOR USE

SoloSpec™ Disposable Sigmoidoscopes are rigid, graduated endoscopes intended for the examination and diagnosis or treatment of the anus and rectum and are for one-time use only.

The SoloSpec™ Disposable Sigmoidoscopes may be used with compatible, fiber-optic instrument heads and light sources approved for medical use.

Preparing & Using Instruments (Refer to Fig. #2 for details)

1. Remove Obturator (1) from SoloSpec™ Disposable Sigmoidoscopes Body (2) and attach body/tube to lighththead by pushing in fully & then twisting CW to secure.
2. Instrument Light-Head (3): Loosen screw on viewing window (3-2) and open window (3-1), Re-insert the obturator(1) through open window before inserting sigmoidoscope in patient. Insert stem of lighththead (3-3) until it latches in illuminator (4).

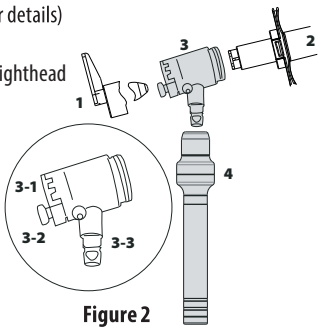

Figure 2

If required connect insufflation bulb to the lighththead. A suitable lubricant may be applied to the tip of the obturator and device tube.

3. Suggestions for use during examination: The window (Fig 2, 3-1) may be opened or closed at any time. Tightening the screw (Fig 2, 3-2) allows the instrument to be made airtight for insufflation.

Insufflation Sets

Orion Concepts Inc. single-use insufflation sets (Fig. 3) are recommended.

When compatible reusable insufflation sets Fig. 4 (1) are used the Orion Concepts Inc single-use filter Fig. 4 (2) prevents potential cross-contamination of the rubber insufflation bulb.

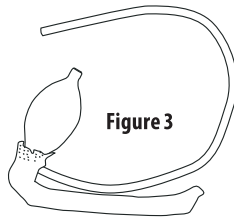

Figure 3

CLEANING PROCEDURE

Instrument head: Please consult the Instructions for Use supplied with such devices and strictly follow the manufactures guidelines for cleaning and reprocessing.

SoloSpec™ Disposable Sigmoidoscopes: These devices are supplied clean, non-sterile in a sealed bag and are meant for one-time use only. After use please dispose of in an approved manner.

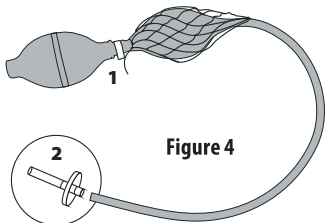

















Figure 4

WARNINGS & CAUTIONS

-  **WARNING:** Devices are not for use with laser equipment. They may reflect, transmit, or absorb laser or other photocoagulation energy, possibly resulting in combustion or emission of irritating gases.
- WARNING:** Devices in transit or storage may be subject to damage beyond the control of the manufacturer or supplier.
- WARNING:** Inspect each device before use.
- WARNING:** Treat used sigmoidoscopes as bio-hazardous, infectious material. Dispose of in a suitable disposal unit and/or in accordance with local regulations.
- WARNING:** Devices are not compatible with gamma radiation or auto-claving.
-  **CAUTION:** To be used by trained personnel only
- CAUTION:** Rx Only. US Federal law restricts this device to sale by or on the order of a physician.
- CAUTION:** Obturator must be in place while inserting sigmoidoscope in patient
- CAUTION:** OCI recommends the use of either disposable insufflation sets or a disposable in-line filter for use with the sigmoidoscope and fiber-optic light head a to prevent contamination of the reusable style rubber insufflation bulb and possible cross contamination between patients.
- CAUTION:** : In-line filters are single-use only and must be disposed of after use to prevent possible risk of infection.
- CAUTION:** SoloSpec™ Disposable Sigmoidoscope are single-use only and must be disposed of after use to prevent possible risk of infection.
- CAUTION:** Protect from sunlight.

Reference Chart				
Figure No.	Device	Class	Size	Product Code
1	SoloSpec™ Disposable Sigmoidoscope	II	Small	42319-1
		II	Standard	42319-2
2 (4)	LED Endoscopic Illuminator	I	—	GS-LEI-A-HP
2 (3)	Fiber Optic Lighththead	I	—	GS-FO-RL
3	Single-use Insufflator Set	I	—	42316-1562
4 (2)	Single-Use Insufflator Filter	I	—	42316-1565

Symbols and Definitions

-  Alerts the user to the possibility of a problem with the device associated with its use or misuse. Such problems include device malfunction, device failure, damage to the device or damage to other property.
-  Caution, consult accompanying documents
-  "WARNING" Alerts the user to the possibility of injury, death, or other serious adverse reactions associated with the use or misuse of the device
-  Date of manufacture (yyyy-mm)
-  Recyclable packaging materials
-  Catalogue number
-  Batch code
-  Non-sterile
-  Manufacturer
-  Temperature limitation
-  Keep away from rain
-  Protect from sunlight
-  Do not reuse
-  Use by the date